



**AW50 Anti Material Sniper Rifle
0.50 Calibre
&
Telescopic Sight
SuB 3-12x50 MKII 0.2 MRAD**



User Manual

Published By Accuracy International Limited

UK & Rest Of World (Excluding USA)

Accuracy International Ltd.

P.O. Box 81

Portsmouth

Hampshire

PO3 5SJ

United Kingdom

Tel: +44 (0)23 9267 1225

Fax: +44 (0)23 9269 1852

Email: precision@accint.org

USA Only

Accuracy International North America

P.O. Box 5267

Oak Ridge

TN 37831

USA

Tel: (865) 482-0330

Fax: (865) 482-0336

Email: AINA@accuracyinternational.org

Contents

	<u>Page</u>
1.0 Introduction	4
1.1 What's Covered Within This Manual	4
1.2 Accuracy International	5
1.3 General Description – Rifle	5
2.0 Technical Specification – Rifle	6
3.0 Top Level GA/Parts Identification	7
4.0 Safety	8
4.1 General	8
4.2 Safety Features	8
4.3 Firing Pin Cocking Indicator	9
4.4 Safe Handling Instructions	10
4.5 Checking That The Rifle Is Unloaded	11
4.6 Checking That The Bore Is Free Of Obstructions	11
4.7 Safety Lever Operation	12
4.8 Checking The Firing Pin's Safe Operation	12
5.0 Operating Instructions – Rifle	13
5.1 Assembling The Rifle	13
5.2 Unfolding & Folding The Stock	13
5.3 Fitting & Removing The Bipod	14
5.4 Fitting & Removal Of The Hand Stop/Bipod Mount (<i>Accessory, where ordered</i>)	15
5.5 Fitting & Removal Of The Scope/Mount (<i>Accessory, where ordered</i>)	16
5.6 Fitting & Removal Of The Bolt	18
5.7 Insertion & Removal Of The Magazine	19
5.8 Setting Up The Rifle	20
5.9 Holding The Rifle	20
5.10 Bipod Adjustment	21
5.11 Third Leg Adjustment	21
5.12 Preparing To Fire The Rifle	22
5.13 Loading	22
5.14 Firing & Operating The Bolt	23
5.15 Reloading	24
5.16 Unloading	24
5.17 Unloading A Live Cartridge	24
5.18 Zeroing The Rifle To A Telescopic Sight	26
5.19 Iron Sights (<i>Accessory, where ordered</i>)	28
5.20 Fitting & Removing The Iron Sights	28
5.21 Zeroing The Rifle To The Iron Sights	29
5.22 Disassembling The Rifle	30
5.23 Stripping The Magazine	30
5.24 Tests After Reassembly	32

	<u>Page</u>
6.0 User Maintenance – Rifle	33
6.1 General	33
6.2 Cleaning & Lubricating Before Firing	33
6.3 Cleaning The Barrel & Chamber Before Firing	34
6.4 Cleaning & Lubricating After Firing	36
6.5 To Clean Heavy Copper Fouling	36
7.0 Recommended Lubricates & Cleaning Solutions	37
8.0 Operating Instructions – Telescope <i>(Accessory, where ordered)</i>	38
8.1 General Description – Telescope	38
8.2 AI Reticule	39
8.3 Eye Relief	41
8.4 Eye Relief Adjustment	41
8.5 Eyepiece Dioptre Adjustment	42
8.6 Elevation Adjustment	42
8.7 Windage Adjustment	42
8.8 Parallax Adjustment	42
9.0 User Maintenance – Telescope	43
9.1 General	43
9.2 Cleaning The Telescope	43
10.0 Accuracy & Ammunition	44
11.0 User Tips	44
12.0 Customer Communication	45
13.0 Shooting Log	46

Illustrations

Fig.		<u>Page</u>
01	General Arrangement/Parts Identification	7
02	Cocking Piece Indicator – Cocked	9
03	Cocking Piece Indicator – Fired	9
04	Bipod	14
05	Fitting & Removal Of The Bipod	14
06	Fitting & Removal Of The Hand Stop/Bipod Mount	15
07	Scope Mount	16
08	Fitting The Scope Mount Onto The Rail	16
09	Fitting & Removal Of The Bolt	18
10	Setting Up The Rifle	20
11	Third Leg Adjustment	21
12	Iron Sights – Rear Sight	28
13	Iron Sights – Fore Sight	28
14	Stripped Magazine Assembly	30
15	Stripping The Magazine – Removing The Base Plate Stage 1	31
16	Stripping The Magazine – Removing The Base Plate Stage 2	31
17	Stripped Magazine - Removing The Spring Assembly	32
18	Schmidt und Bender 3-12x50 MKII 0.2 MRAD Telescope	38
19	AI Reticule	39
20	Range Finding Stadia (400 – 1000 M)	40
21	Range Finding Stadia (100 – 250 M)	40
22	Eye Relief	41

1.0 Introduction

1.1 What Is Covered Within This Manual

1.1.1 The information contained within this manual will provide the user with sufficient instruction for the continual safe usage of the AW50 and some its common accessories.

Note: - Accessories must be specified at the time of order.

1.1.2 **Maintenance and repair instruction beyond what the user could be expected to conduct using the standard user tool/cleaning kit is not covered within this document.**

The user should attempt no weapon stripping beyond that mentioned herein.

The AW50 Maintenance Manual provides detailed maintenance and repair instruction.

1.1.3 This manual assumes a basic level of user familiarity with shooting.

1.1.4 Note: - The manual has been written assuming the user is right handed.
Operating instructions may need to be varied to accommodate a left handed user

1.2 Accuracy International

1.2.1 Accuracy International was formed in 1978 to design and build tactical rifles.

The original design ethos combined two factors into a unique package. Namely the incorporation of performance enhancing features learned in Olympic and international target shooting onto a platform exhibiting full military ruggedness.

The current designs faithfully follow this original concept but also benefit from over twenty years of continuous improvement.

These improvements are not cosmetic but are driven solely by the needs of the users, highly trained military and police units in over 50 countries worldwide.

Such units are exposed to 'live' tactical situations on a daily basis and in the most demanding environments where first shot accuracy is critical.

The rifles are produced in a purpose built 20,000sq. ft. facility in the UK, operating a management system certified to BS EN ISO9001.

All components are manufactured to Accuracy International's designs to ensure that they are optimised for the function they must perform, something that cannot be achieved with a ruggedised-sporting weapon.

1.3 General Description – Rifle

1.3.1 The AW50 sniper rifle is an evolution, which builds on Accuracy International's established family of highly successful AW rifles.

A bolt-action single shot rifle with free-floating barrel and a magazine capacity of five rounds fulfils the need for a highly accurate large calibre anti-material sniper rifle.

In common with all the AW rifles it utilises an aluminium chassis system, which ensures insensitivity to temperature and humidity, thus ensuring a constant zero.

The AW50's clamshell polypropylene stocksides and forend are bolted directly to the chassis.

If required, the fore end may be removed for customisation or fitment of alternative mounting/support systems.

A folding stock is standard, to improve the rifle's compactness for ease of transit.

A spring-damped butt improves the user's comfort during repeated firing by considerably reducing the rifle's recoil.

The action's integral Mil Standard 1913 rail allows for universal scope mounting.

2.0 Technical Specification – Rifle

Calibre:	0.50 BMG
Weight:	13.5 kg (30lb) Weighed with all accessories fitted minus scope, empty magazine.
Length Overall:	1353 mm (53.3")
Length Folded:	1105 mm (43.5")
Action:	Steel, front locking, integral Mil Std 1913 rail
Bolt:	60° opening, six lugs, 8 mm (.315") striker fall
Trigger:	Two stage adjustable, set at 1.8kg (4lbs)
Safety Lever:	“Safe” and “Fire” modes only. “Safe” withdraws and blocks the firing pin, physically blocks the trigger and locks the bolt in the closed position.
Barrel:	692 mm (27.25") Stainless steel match grade 1:15 twist fitted with a muzzle brake
Muzzle Velocity:	825 m/sec (2707 ft/sec) with standard ball ammunition Note: - This varies between ammunition manufacturer
Stock:	Folding type alloy chassis enclosed in scuff resistance stock sides. Fitted with removable bipod, cheekpiece, anti recoil butt, adjustable third leg support and sling loops.
Bipod:	Universal, quick detachable folding type. Provides 10° loll either side of the central position.
Rear Support Leg:	Quick release with fine adjustment
Magazine:	Detachable box type containing five rounds
Carriage	Four sling loops allowing hand & shoulder sling or biathlon style harness for backpack style carriage
Iron Sights: (Accessory)	The emergency peep iron sight has five settings from 200 m out to 1000 m. The foresight has coarse windage adjustment (via repositioning the muzzle brake) and fine elevation adjustment. Rearsight has fine windage adjustment

3.0 Top Level GA/Parts Identification

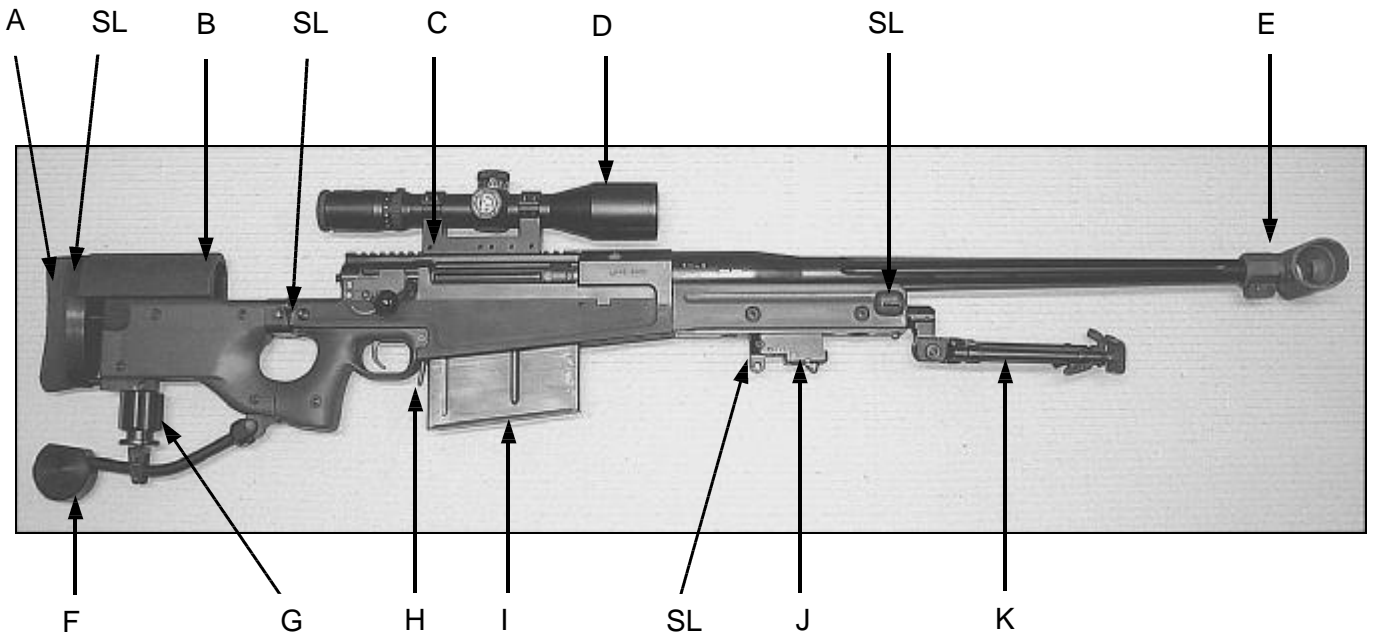

- | | | | | | |
|---|----------------------|----|------------------------------|---|--------------------------------|
| A | Butt Pad | H | Magazine Release Catch | N | Bolt Release Catch |
| B | Cheekpiece | I | Magazine | O | Safety Lever |
| C | Scope Mount | J | Hand Stop/Bipod Mount | P | Folding Stock Hinges |
| D | Telescope | K | Bipod | R | Folding Stock Retaining Spigot |
| E | Muzzle Brake | SL | Sling Loop Attachment Points | | |
| F | Third Leg Support | L | Folding Stock Release Button | | |
| G | Third Leg Adjustment | M | Bolt Handle | | |

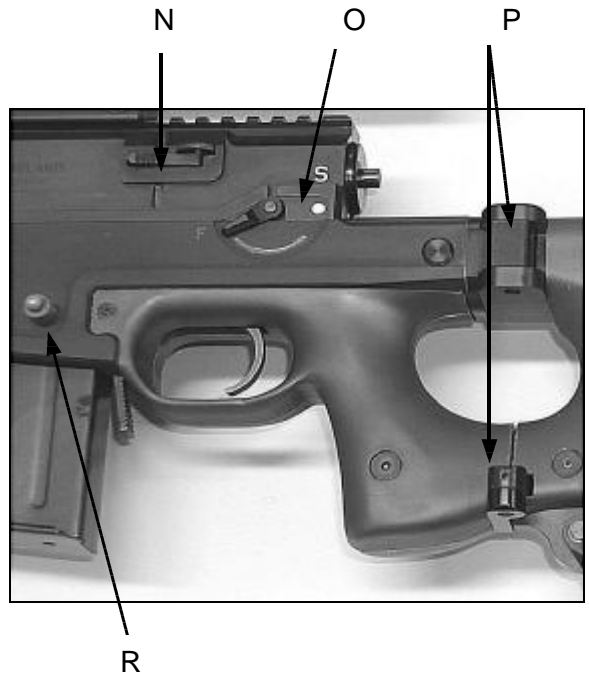
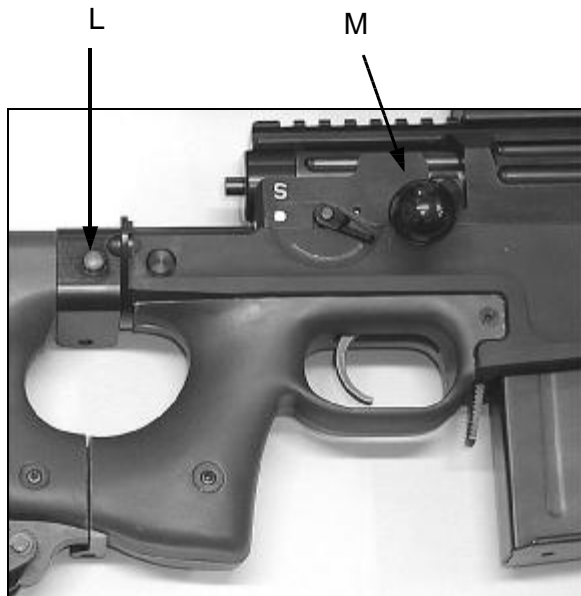

Fig. 01 General Arrangement/Parts Identification

4.0 Safety

4.1 General

4.1.1 **This manual must be read and fully understood before attempting to use the weapon system.**

4.1.2 From time to time the manual uses cautionary notices to alert the user to either safety imperative or potential instances which may result in causing damage to the weapon system, as shown below: -

4.1.3



CAUTION

The safety precautions set out under section 4.4 "Safe Handling Instructions", must be strictly adhered to, when: -

- On initial receipt of weapon
- Before operating the rifle
- After use before maintenance
- Before any inspection
- When the documentation recommends it

4.2 Safety Features

4.2.1 The AW50's bolt utilises six forward locking lugs.

When in the closed position, the bolt head is completely enclosed and supported within the lock ring and the action body.

4.2.2 The firing pin cannot protrude from the front of the bolt face unless the bolt is in the fully closed position.

4.2.3 Gas leakage from the rear of the action is minimised by a tight fitting bolt. Should there be an excessive build up of gas, it will be safety vented away through two exhaust ports in the action and one in the bolt.

Note: - In normal service the gas ports are fitted with red plastic caps to prevent the ingress of debris/moisture. New caps should always be fitted after gas has been exhausted through the ports.

4.2.4 The rifle is fitted with a two-stage trigger, which gives a fine let off. Accidental discharge that might be caused by slamming the bolt or dropping the rifle is reduced through increased first stage sear engagement.

4.3 Firing Pin Cocking Indicator

4.3.1 The user can ascertain whether or not the rifle is cocked by the position of cocking piece indicator protruding through the rear of the action.

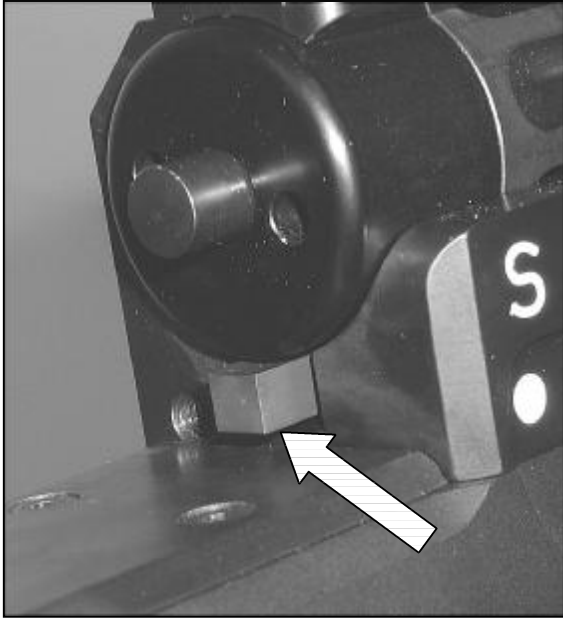

Fig. 02 Cocking Piece Indicator - Cocked

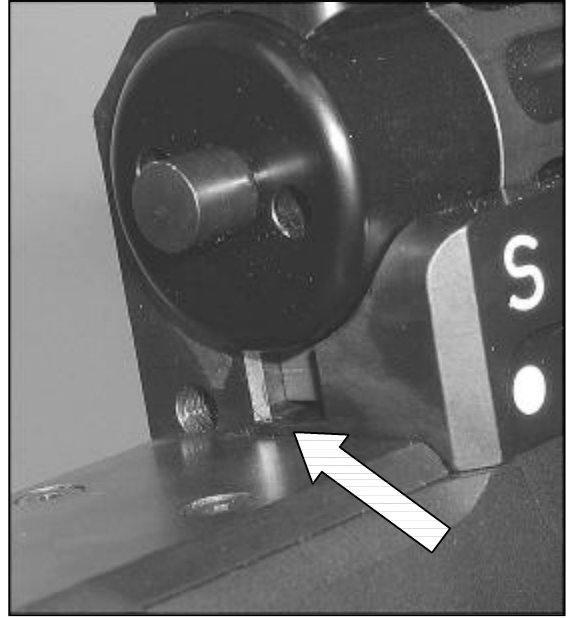

Fig. 03 Cocking Piece Indicator - Fired

4.4 Safe Handling Instructions

4.4.1 It is forbidden without any reason to point the rifle at anybody.

4.4.2 When users are unaware of the weapon status (half loaded, loaded or unloaded), it should always be assumed that it is LOADED.

4.4.3 A weapon which is to be handed over must be presented unloaded and with the bolt open, in the rearwards position.

4.4.4



CAUTION

Before handling the rifle or attempting any operation, the user must ensure theirs and the safety of others by:-

- Standing behind the weapon
- Ensuring it is pointing in a safe direction
- Checking it is unloaded and safe to handle

4.4.5



CAUTION

NEVER fire the rifle before you have ensured rifle that: -

- The muzzle brake is securely fitted and is not clogged or obstructed
- The serial numbers of the action body and the bolt assembly match

4.4.6 Failure to fully close the bolt every time the bolt is manipulated could result in a live round being left in the chamber, as the extractor does not engage the cartridge rim unless the bolt is fully closed.

4.4.7



CAUTION

When operating the bolt **ALWAYS** cycle fully i.e. completely open and close the bolt every time it is manipulated.

4.4.8 Tactical movements with a loaded weapon are only to be performed with the safety lever set to the "SAFE position" (opposite the white dot).

4.5 Checking That The Rifle Is Unloaded

- 4.5.1 Remove the magazine from the rifle, see section 5.7 "Insertion & Removal Of The Magazine" and ensure it is clear of ammunition.
- 4.5.2 Check that the safety lever is set on the "FIRE" position (opposite the red dot).
- 4.5.3 Raise the bolt handle and slide the bolt fully to the rear.
- 4.5.4 Check that the action is clear of ammunition by looking through the ejection port and using a finger to feel inside the chamber.
- 4.5.5 The bolt should be left open or removed whilst handling rifle, see section 5.6 "Fitting & Removal Of The Bolt" for instruction on how to remove the bolt.
- 4.5.6 To close the bolt without causing unnecessary stress on the firing pin and bolt assembly, pull the trigger shoe and whilst holding it to the rear, fully close the bolt before releasing the trigger.
- 4.5.7 Replace an empty magazine in the weapon.
- 4.5.8 The rifle may now be handled safely.

4.5.9

 CAUTION	Before firing the rifle, always check the bore is free of obstructions.
--	---

4.6 Checking That The Bore Is Free Of Obstructions

- 4.6.1 Check that the rifle is unloaded, see section 4.5 "Checking That The Rifle Is Unloaded".
- 4.6.2 Fold the stock and remove the bolt, see section 5.2 "Unfolding & Folding The Stock" and 5.6 "Fitting & Removal Of The Bolt" for relevant instruction.
- 4.6.3 Look through the barrel to ensure that it is free from obstructions and then replace the bolt.

4.7 Safety Lever Operation

4.7.1 The AW50 has two modes of operation: -

- Safe
- Fire

4.7.2



CAUTION

There is only one position where the rifle is safe.

This is when the lever is **EXACTLY** opposite the white dot under the "S".

No other position is safe.

4.7.3 The safety lever can only be applied after the rifle has been cocked.

4.7.4 With the safety lever applied: -

- The firing pin is withdrawn and is physically blocked from coming forward.
- The trigger is physically blocked.
- The bolt is locked in the closed position.

4.8 Checking The Firing Pin's Safe Operation

4.8.1 Open and close the bolt to leave it in the cocked position.

4.8.2 Move the safety lever into the "SAFE" position.

4.8.3 Pull and release the trigger 6 times and remove your finger from the trigger.

4.8.4 Push the safety lever forward into the "FIRE" position.

4.8.5 If the rifle is operating correctly the firing pin should not be released; it will still be retained by the trigger mechanism.

4.8.6 Pull the trigger to release the firing pin.

4.8.7 If moving the safety lever to the "FIRE" position releases the firing pin; then the rifle is deemed to be unsafe and must be returned to the Base Armourer for maintenance.

5.0 Operating Instructions – Rifle

5.1 Assembling The Rifle

5.1.1 Rifles are normally supplied as complete units within their transit cases (with the scope, bolt, bipod and magazine already fitted to the rifle).

Note: - Rifles will be folded during transit.

5.1.2 However, if the rifles are broken down for transport they will need to be assembled in sequence, using the instructions below.

5.2 Unfolding & Folding The Stock

5.2.1 To unfold the stock, support the rifle within one arm and taking hold the butt with the other hand give a quick/sharp pull to release the retaining spigot from the female bush.

5.2.2 Continue to pull the stock round until it 'snaps' back into the locked position.

5.2.3 To fold the stock press the release button, located on the right hand side of the chassis, just behind the action body.

5.2.4 Push the rear end of the stock round to the left hand side of the rifle until it's female bush engages on the male retaining spigot.

5.2.5 The stock is now held in the folded position.

5.3 Fitting & Removal Of The Bipod

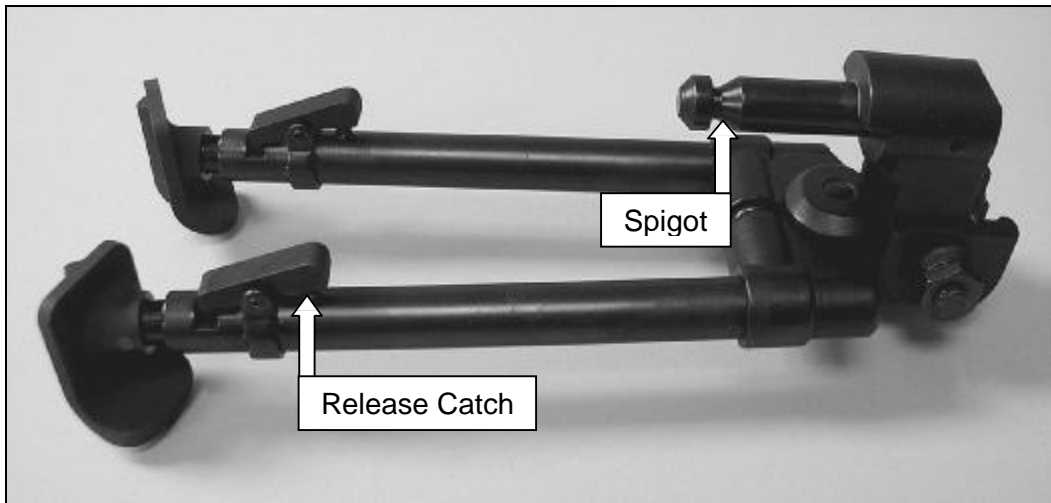

Fig. 04 Bipod

- 5.3.1 To fit the bipod, insert its spigot into the socket at the front of the rifle forend (or the hand stop/bipod mount, where fitted) until the catch engages.
- 5.3.2 Correct engagement can be assured on hearing an audible 'click' when the bipod is pushed home.
- 5.3.3 Alternatively, when operational the user can reduce the noise made inserting the bipod by holding the bipod release catch open whilst the bipod is pushed home.
- 5.3.4 To remove the bipod, depress the bipod release catch and pull the bipod out of the socket.

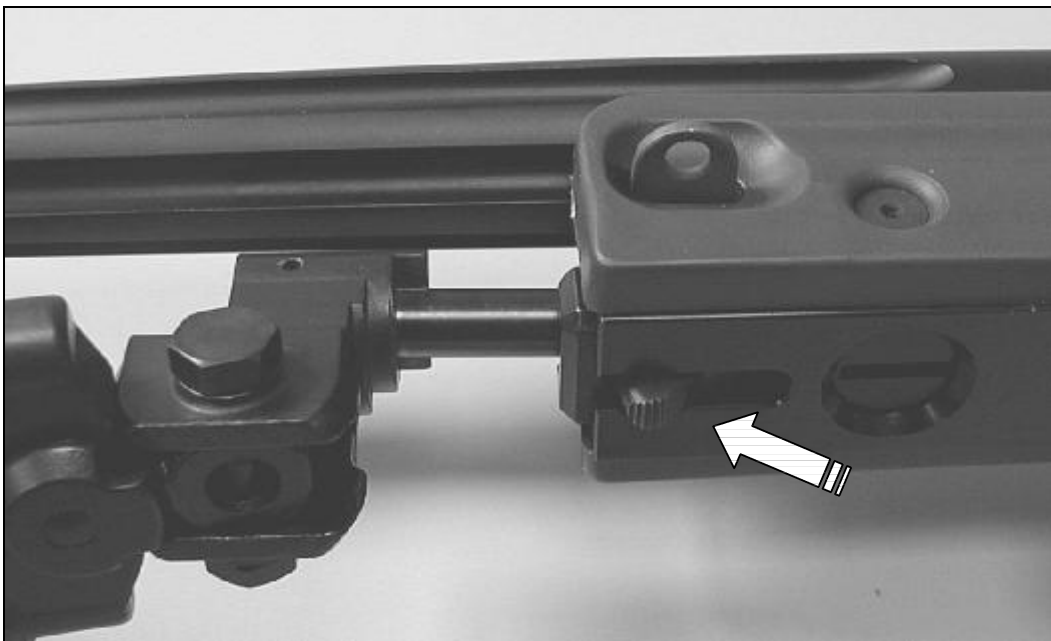

Fig. 05 Fitting & Removal Of The Bipod

5.4 Fitting & Removal Of The Hand Stop/Bipod Mount

- 5.4.1 The adjustable hand stop/bipod mount allows the user to adjust the bipod's position along the length of the forend.
- 5.4.2 To fit the adjustable hand stop/bipod mount, use the universal Allen key set to loosen the screw/nut until there is sufficient clearance for the mount to be fitted, but do not undo it completely.
- 5.4.3 Where the rifle cannot be turned over, use the Allen key to push against the screw to maintain the clearance whilst inserting the hand stop/bipod mount into the circular opening at the end of the keyway.
- 5.4.4 Slide the hand stop/bipod mount along the keyway and tighten the screw/nut when it is in the desired position.
- 5.4.5 To remove the hand stop/bipod mount, loosen the screw/nut and remove it through the circular opening at the end of the keyway.



Fig. 06 Fitting & Removal Of The Hand Stop/Bipod Mount

5.5 Fitting & Removal Of The Scope/Mount

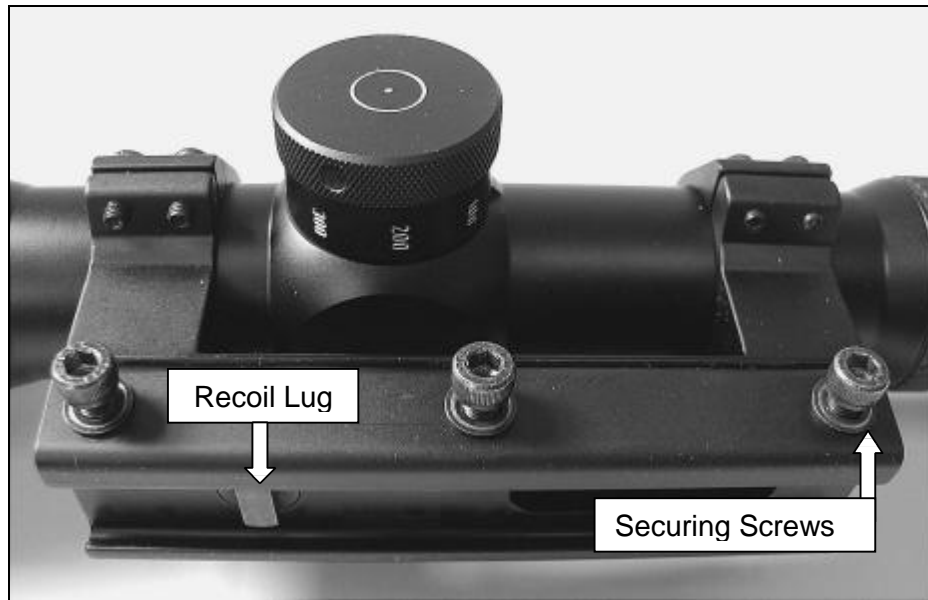

Fig. 07 Scope Mount

- 5.5.1 To fit the scope/mount, use the universal Allen key set to loosen the three mount screws (if they have been done up) until there is sufficient clearance for the mount to be fitted.
- 5.5.2 Present the mount to the Picatinny rail at an angle of approximately 30 degrees and align the recoil lug with the appropriate slot.
- 5.5.3 Hook the mount's fixed dovetail (on the opposite side to the securing screws) onto the rail's mating face before rolling the mount over to the upright position.

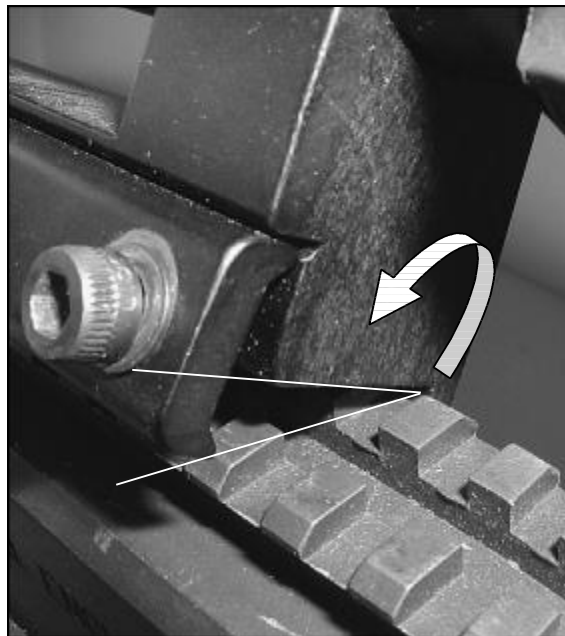

Fig. 08 Fitting The Scope Mount Onto The Rail

- 5.5.4 Before re-tightening the mount securing screws ensure that the mount's recoil lugs are pushed forward against the slot in the rail.
- 5.5.5 It is recommended that a routine be established for retightening the screws to ensure that the scope/mount is fitted consistently each time.
- 5.5.6 Typically after the bolts have been made finger tight, the front and rear screws should be tighten alternately by $\frac{1}{4}$ of a turn at a time, until they are tight.

The centre screw can then be tightened to the same extent.

- 5.5.7 To remove the scope/mount, loosen the clamp plate's three screws until there is sufficient clearance for the mount to be lifted off.

5.5.8



CAUTION

It is recommended that the scope is re-zeroed following **any** changes to its position.

Unnecessary removal/refitting of the scope from the picatinny rail or within the mount's scope rings should therefore be avoided.

5.6 Fitting & Removal Of The Bolt

- 5.6.1 The bolt can only be fitted/removed from the rifle when the stock is folded position and the safety lever is in the “Fire” position.
- 5.6.2 To fit the bolt, ensure that the safety lever is set in the “Fire” position.
- 5.6.3 Check that the serial numbers of the bolt and the action are the same. If they are different do not fit the bolt and contact the Base Armourer.
- 5.6.4 Fold the stock back to allow sufficient clearance for the bolt to be replaced. Its recommended that it be folded fully back onto itself and locked in this position see section 5.2 “Unfolding & Folding The Stock”.
- 5.6.5 Fit the bolt into the bolt way and whilst depressing the bolt release catch, slide the bolt fully forwards.
- 5.6.6 Release the bolt catch, pull the trigger shoe and whilst holding it to the rear, close the bolt before releasing the trigger shoe.
- 5.6.7 To remove the bolt, hold the bolt handle in the right hand. Raise the handle and slide the bolt rearwards until it stops on the bolt catch.
- 5.6.8 Using the left hand, depress the bolt release catch and fully withdraw the bolt from the action.



Fig. 09 Fitting & Removal Of The Bolt

5.7 Insertion & Removal Of The Magazine

- 5.7.1 The box magazine is inserted by locating it into the opening in the underside of the rifle.
- 5.7.2 Hold the magazine by its base using the left hand and push it upwards until the catch engages.
- 5.7.3 Correct engagement can be assured on hearing an audible 'click' when the magazine is pushed home.
- 5.7.4 Alternatively, when operational the user can reduce the noise made inserting the magazine by holding the magazine release catch open whilst the magazine is pushed home.

5.7.5



CAUTION

Always check that the magazine has been correctly engaged and is secure, by pulling down on the base plate.

- 5.7.6 To remove the magazine, push the magazine release catch forward with the thumb of the right hand, whilst holding the left hand underneath the magazine to support it as it comes away from the rifle.

5.8 Setting Up The Rifle

5.9 Holding The Rifle

5.9.1 In its standard form, the rifle has been designed for shooting from the prone position, utilising the bipod and the third leg to support and help absorb recoil.

Note: - Use of a suitable mounting capable of absorbing the recoil is recommended when the rifle is to be shot in any other position.

5.9.2 Having adopted the prone position, hold the pistol grip with the right hand and pull the rifle firmly into the shoulder.

5.9.3 Rest the cheek on the butt's cheekpiece so that the eye is looking directly through the sight.

5.9.4 If necessary adjust position of the telescopic sight to obtain correct eye relief see section 8.4 "Eye Relief Adjustment".

5.9.5 Position the left hand so that it grips the fine adjustment knob on the underside of the butt.

5.9.6 This provides additional support but it also permits fine adjustments to be made to the height of third leg whilst remaining the firing position.



Fig. 10 Setting Up The Rifle

5.9.7 The bipod and the third leg should be adjusted to align the rifle with the target in various terrains and allow the user to comfortably maintain the hold over an extended period of time.

5.10 Bipod Adjustment

- 5.10.1 The bipod's legs can be extended together or independently to compensate for variations in the ground level.
- 5.10.2 A castellation along the leg's length allows the spring-loaded leg to be extendable and to be locked into a secure position.
- 5.10.3 To adjust the bipod's height, depress the bipod leg catch release the leg to extend to the castellation appropriate to the desired height.

5.10.4

	Always ensure that the bipod leg catch is securely engaged in the castellation.
CAUTION	

5.11 Third Leg Adjustment

- 5.11.1 The third leg can be coarsely adjusted via spring loaded quick release mechanism and finally adjusted with the fine adjustment knob to obtain an exact height.
- 5.11.2 A castellation along the inner sleeve's length allows the spring-loaded leg to be extendable via quick release mechanism and to be locked into a secure position.
- 5.11.3 To operate the quick release mechanism, take the weight off the third leg and place two fingers either side of the disc below the fine adjustment knob.
- 5.11.4 Pull down on the disc to release the leg to extend to the castellation appropriate to the desired height.



Fig. 11 Third Leg Adjustment

- 5.11.5 The height can be finely adjusted within the prone position by using the left hand to rotate the fine adjustment knob.
- If the butt is too low, rotate the knob clockwise to raise.
 - If the butt is too high, rotate the knob anti-clockwise to lower.

5.12 Preparing To Fire The Rifle

5.12.1



CAUTION

Ensure that the rifle has been correctly cleaned and lubricated before use, see section 6.2 “Cleaning & Lubricating Before Firing” and 6.3 “Cleaning The Barrel & Chamber Before Firing”.

Whenever loading, reloading or unloading ensure that the fingers are kept outside of the trigger guard.

5.13 Loading

5.13.1

To load the rifle, place a full magazine into the magazine well.

5.13.2

Push the magazine upwards until the magazine retaining catch engages on the magazine’s lug.

5.13.3

If the bolt is in the closed position, open the bolt by fully raising the bolt lever and pulling it backwards until it reaches its stop.

5.13.4

To feed a round from the magazine into the chamber, push the bolt lever fully forward and then down into the closed position.

5.13.5



CAUTION

The rifle is now cocked and is able to be fired. The safety lever should be applied as necessary.

5.13.6



CAUTION

The extractor does not engage the cartridge rim unless the bolt is fully closed.

Failure to fully close the bolt every time that it is manipulated could result in a live round being left in the chamber.

5.13.7 Note: -

If It is difficult to get the magazine to engage with the bolt closed or the first round is difficult to feed into the chamber check the that the magazine has not been over loaded.

5.14 Firing & Operating The Bolt

- 5.14.1 The sequence detailed below assumes that the user has already identified the target and made the relevant adjustments to optimise the scope or iron sight.
- 5.14.2 Set the range and windage on whichever sighting system is to be employed.
- 5.14.3 Move the safety lever to the “Fire” position.
- 5.14.4 Push the rifle firmly into the bipod with the shoulder (to pull back on the bipod can cause vertical stringing of shots, especially on soft ground).
- 5.14.5 Place the finger naturally on the trigger **without** pulling it.
- 5.14.6 Whilst taking a few deep breaths take up the first pressure.
- 5.14.7 Breathe out normally and perfect the aim, whilst applying a gradual increase of trigger pressure to fire.

Note: - Exhaling reduces pulse beat whilst in the prone position on the ground
- 5.14.8 Maintain trigger pressure and concentration on the aim until the weapon recovers from the recoil (follow through).
- 5.14.9 Release the trigger, resume normal breathing and observe the target.
- 5.14.10 To minimise the movement of the rifle and body (right handed users only) remain in the aim position during recycling.
- 5.14.11 Place a thumb on the top of the action and grasp the bolt handle with the fingers of the right hand.
- 5.14.12 Bring the fingers up towards the thumb. If any resistance is felt during the initial unseating of the fired case (primary extraction), increase the upward pressure on the bolt handle.
- 5.14.13 Pull the bolt to its most rearward position i.e. to touch the bolt stop, to allow the fired case to be ejected and to pick up the next round.
- 5.14.14 Push the bolt forward to feed the next round into the chamber and close the bolt.
- 5.14.15 Repeat this sequence of operation if further shots are necessary.

5.15 Reloading

- 5.15.1 Remove the expended magazine and insert a fresh one as previously described, see section 5.7 "Insertion & Removal Of The Magazine"
- 5.15.2 Close the bolt (open it fully where was previously left in the closed position) to feed a new round into the chamber.
- 5.15.3 Move the safety lever to the "Safe" position.
- 5.15.4 The rifle is now loaded, cocked and ready to engage a new target.

5.16 Unloading

- 5.16.1 Remove the magazine from the rifle.
- 5.16.2 Open the bolt and pull it to its most rearward position i.e. to touch the bolt stop, to allow the fired case to be ejected.
- 5.16.3 Check that the rifle is clear of ammunition by looking through the ejection port and using a finger to feel inside the chamber.
- 5.16.4 The bolt should be left open, unless the rifle is to be put into its transit case, in which case: -
- 5.16.5 Pull the trigger shoe and whilst holding it backwards, close the bolt before releasing the trigger.
- 5.16.6 Replace an empty magazine in the weapon.

5.17 Unloading A Live Cartridge

- 5.17.1 Set the safety lever as necessary to the "Fire" position.
- 5.17.2 Remove the magazine from the rifle
- 5.17.3 Cup the right hand and position it just to the side and below the ejection port to catch the round as it is ejected.
- 5.17.4 Using the left hand reach over the rifle and cycle the bolt to unload the chamber.
- 5.17.5 Note: - The user may maintain a lower profile by reversing the right and left hands within the procedure above.

 However it means that it is necessary to reach under the rifle restricting the ease of movement and attempt to catch the round with a potentially weaker hand.

- 5.17.6 Check that rifle is clear of ammunition by looking through the ejection port and using a finger to feel inside the chamber.
- 5.17.7 The bolt should be left open, unless the rifle is to be put into its transit case, in which case: -
- 5.17.8 Pull the trigger shoe and whilst holding it to the rear, close the bolt before releasing the trigger.

5.17.9



CAUTION

All live rounds **MUST** be removed from the magazines (either in the rifle or separate) prior to being stored in the transit case.

5.18 Zeroing The Rifle To A Telescopic Sight

5.18.1



Refer to Safe Handling Instructions; see section 4.4 "Safe Handling Instructions".

CAUTION

- 5.18.2 Choose a suitably short range to reduce the wind effects to a minimum, typically 100 metres.
- 5.18.3 Check that the sight's windage is set to zero and elevation drum is set to a mid range position i.e. 9 on the top scale.
- 5.18.4 Check that the zoom is set to its highest magnification and focus the reticule.
- 5.18.5 Open the bolt, insert a loaded magazine and close the bolt.
- 5.18.6 Whilst looking through the telescope, align reticule's aiming point on the target's aiming mark.
- 5.18.7 Fire one shot.
- 5.18.8 Sandbag or hold the rifle carefully so it cannot move from its original point of aim.
- 5.18.9 Taking care not to move the rifle, gently rotate the windage drum until reticule is in vertical line with the shot hole.
- If the shot is too much to the left, rotate the windage drum clockwise.
 - If the shot is too much to the right, rotate it anti-clockwise.
- 5.18.10 Still taking care not to move the rifle, rotate the elevation drum until the reticule's aiming point is over the bullet hole.
- If the shot is too low, rotate the elevation drum clockwise.
 - If the shot is too high, rotate the elevation drum anti-clockwise.
- 5.18.11 Note: - Where there is insufficient movement to allow the drums to be adjusted, loosen the two grub screws securing the drum.
- Rotate the drum to allow additional movement in the direction required, before retightening the grub screws.
- 5.18.12 Fire a second shot at the original aiming mark (or 2 to 3 to form a group).
- 5.18.13 'Click' the windage and elevation drums to finely adjust the reticule's aiming mark over the point of impact.
- 5.18.14 Fire a five shot group and make any final adjustments. Repeat group if required for confirmation.

- 5.18.15 On completion of zeroing, record of the position of elevation and windage drums.
- 5.18.16 Whilst holding the drums firmly between the fingers so as not to lose the setting, loosen the grub screws (2 ea. per drum) using the universal Allen key set.
- 5.18.17 Rotate the drums to zero and re-tighten the grub screws.
- 5.18.18 The rifle is now zeroed.
- 5.18.19 By using the elevation markings on the sight-drum and a graph, the true settings at various ranges can be established and marked on the graph when shooting with the same ammunition type as used when the rifle was zeroed.

A graph will enable the sniper to establish the correct elevation setting at all usable ranges.

5.19 Iron Sights

5.19.1 A disc type iron sight set is provided with the AW50 for use in the event of a failure with telescopic sight.

5.19.2 The sight has settings for ranges of 200, 400, 600, 800 and 1000 metres.

A larger aperture for use in low light conditions is provided at number 4, 400 metres position.

5.19.3 For zeroing purposes, the rear sight is adjustable for windage and Foresight adjustable for elevation.

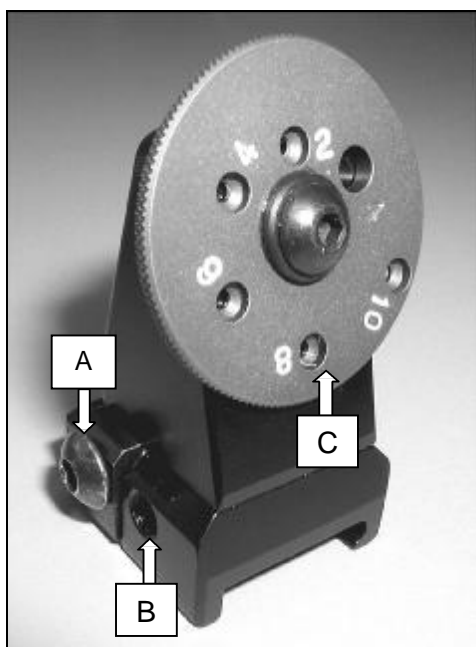

Fig. 12 Iron Sights – Rear Sight

- A Mount Securing Screw
- B Windage Adjustment Screws
- C Range Elevation Disc

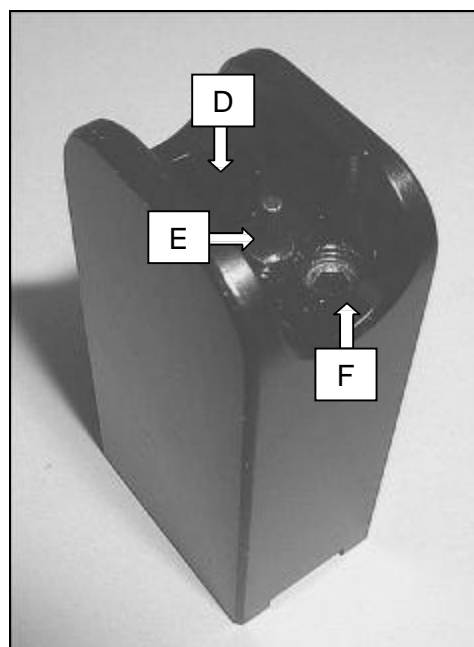

Fig. 13 Iron Sights – Fore Sight

- D Mount Securing Screw
- E Post
- F Vertical Adjustment

5.20 Fitting & Removing The Iron Sights

5.20.1 To fit the rear sight, use the universal Allen key set to loosen the screw in the mount's base until there is sufficient clearance for it to be fitted to the rail.

Note: - The mount does not have a recoil lug so it can be slid along the rail to whatever position the user finds comfortable when in the prone position.

5.20.2 Tighten the mount's screw.

5.20.3 To fit the foresight, locate the sight's keyway over the muzzle brake's mating face (with the post foremost) so that the securing screw can be tightened using the universal Allen key set.

5.20.4 Loosen the screws to remove the sights.

5.21 Zeroing The Rifle To The Iron Sights

5.21.1

	Refer to Safe Handling Instructions; see section 4.4 "Safe Handling Instructions".
CAUTION	

5.21.2 Set up a large target at 200 metres.

5.21.3 Rotate the rear sight's disc to the number 2 position and ensure that the body of the sight is centrally located on its base (see below for instruction on how to adjust).

5.21.4 Open the bolt, insert a loaded magazine and close the bolt.

5.21.5 Look through the disc's number 2 hole and with the target's aiming mark centrally aligned within the aperture; position the top of the post so that it is central and aligns with the base of the aiming mark.

5.21.6 Fire three shots and note the Mean Point Of Impact (MPI) on the target.

5.21.7 For horizontal adjustments to the MPI, use the universal Allen key set to loosen the windage screws on either side of the sight's main body.

- If MPI is too much to the left, move the sight to the right by undoing the right hand side screw and tightening the left, by equal amounts.
- If MPI is too much to the right, move the sight to the left by undoing the left hand side screw and tightening the right, by equal amounts.

Note: - If the error is too great and cannot be adjusted by the rear sight's windage screws, coarse adjustment may be obtained by loosening the muzzle brake's two clamp screws. However, the direction of adjustment is reversed.

5.21.8 Vertical adjustments are carried out by moving the post's height within the foresight

- If the MPI is too low, turn the screw clockwise to lower the post
- If the MPI is too high, turn the screw anti-clockwise to raise the post

5.21.9 Repeat the process above as required until a satisfactory zero is achieved.

5.21.10 Upon completion, note where the rear sight is fitted on the rail as any deviation may affect the zero.

5.21.11 The rifle is now zeroed at 200m, range elevations are achieved by rotating the disc to the required range.

5.22 Disassembling The Rifle

- 5.22.1 The user should not disassemble the rifle further than that previously described within section 5.1 "Assembling The Rifle".
- 5.22.2 Unlike other AW rifles, the AW50's bolt assembly is non-user maintainable.
- 5.22.3 Under no circumstances should the user conduct any more maintenance other than routine cleaning and lubrication of its external surfaces.
- 5.22.4 A qualified armourer should carry out all further maintenance. If doubt the user should seek the armourers advice.

5.23 Stripping The Magazine

- 5.23.1 Magazines should be stripped if and when they have been exposed to conditions likely to result in a build up of mud, grit or rust.

Care should be taken not to damage the magazine platform or to bend the round securing ears from their original form.

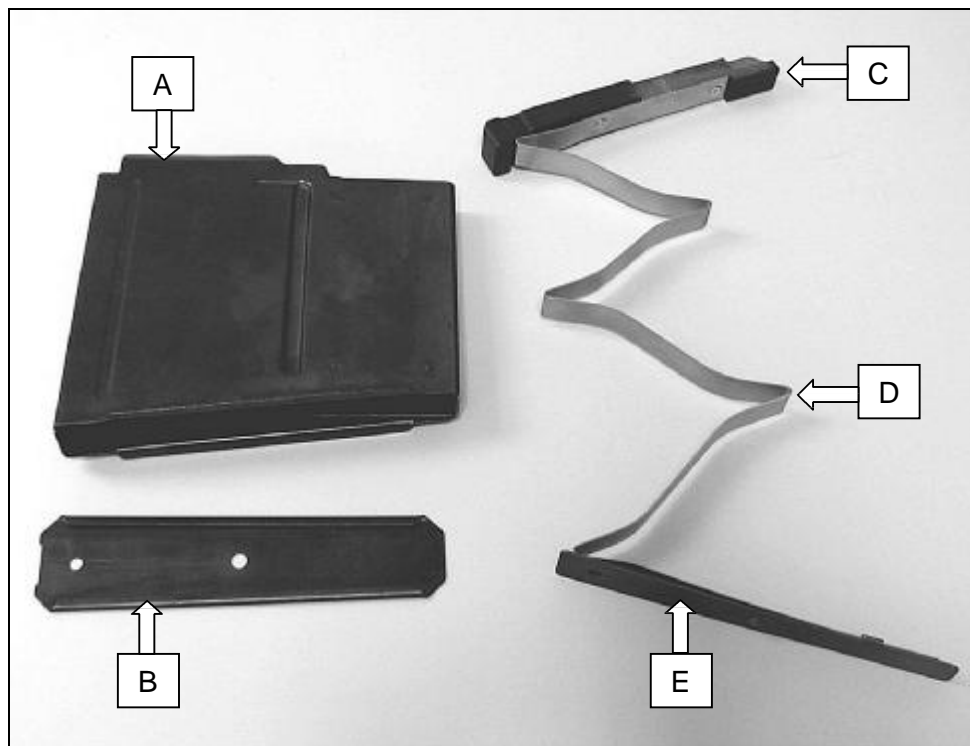

Fig. 14 Stripped Magazine Assembly

- | | | | |
|---|-------------------|---|-----------------------------|
| A | Magazine Body | D | Magazine Spring |
| B | Magazine Base | E | Magazine Base Locking Plate |
| C | Magazine Platform | | |

5.23.2



CAUTION

The magazine platform is under tension.

Keep a hand over the opening when removing the bottom plate, to prevent the spring from 'jumping out'.

5.23.3 To strip the magazine, hold it in the left hand with the bottom plate uppermost.

5.23.4 With the nose of a round, depress the stud located in the bottom plate and slide the bottom plate forwards, part way open.



Fig. 15 Stripping The Magazine – Removing The Base Plate Stage 1

5.23.5 Remove the bullet and whilst holding the right hand over the bottom of the magazine, slide the bottom plate completely off.

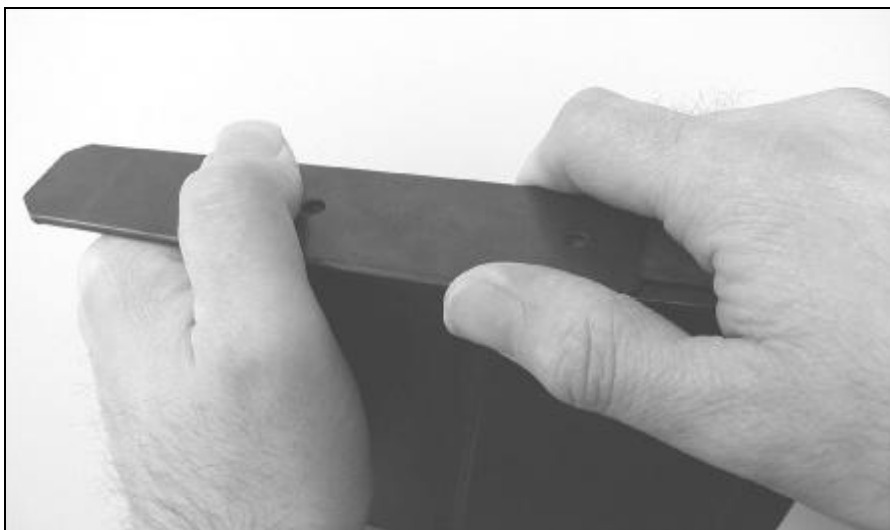

Fig. 16 Stripping The Magazine – Removing The Base Plate Stage 2

- 5.23.6 The spring is now released; **slowly** lift the right hand away, taking hold of the spring as it uncoils from the magazine.



Fig. 17 Stripping The Magazine – Removing The Spring Assembly

- 5.23.7 Carefully feed the spring out of the magazine so not to damage the attached platform.
- 5.23.8 Reassembly is conducted in reverse order to stripping, ensuring that the magazine platform and spring base are correctly aligned with the magazine's profile.

5.24 Tests After Re-assembly

- 5.24.1



CAUTION

Specially prepared “dummy” rounds should be used to conduct this test.

- 5.24.2 Load the magazine with inert test rounds, to its fullest capacity.
- 5.24.3 Whilst loading check to ensure that the lips of the magazine hold each round in position.
- 5.24.4 Load the magazine into a functional rifle.
- 5.24.5 Operate the bolt and check that each round is fed in, extracted and ejected correctly.

6.0 User Maintenance – Rifle

6.1 General

6.1.1 This section only covers the level of maintenance that the user would be expected to perform using the tools supplied with the rifle.

It recognises that a user is unlikely to be able to conduct the same level of maintenance whilst operational.

Complete maintenance procedures are defined in the Maintenance Manual

6.1.2 To ensure the rifle is not damaged whilst being cleaned and lubricated only the recommended tools, cleaning materials and lubricates should be used in accordance with these instructions.

6.1.3 No abrasive material should be used on any part of the rifle. If cleanliness cannot be achieved using the methods and materials described below the fault should be reported to the Base Armourer.

6.1.4 If while cleaning and lubricating the rifle the user identifies any faults or damage, it should be reported to the Base Armourer.

6.2 Cleaning & Lubricating Before Firing

6.2.1 Before firing the rifle it must be cleaned and lubricated as detailed below: -

Part	Lubrication Status
Bore, chamber & barrel - Exterior	N/A - Leave dry
Bore, chamber & barrel - Interior	Clean and leave dry, see section 6.3 "Cleaning The Barrel & Chamber Before Firing".
Bolt – Front face	Clean and leave dry
Bolt - Remaining surfaces	Lightly lubricate with CLP 16 oil
Action body	Lightly lubricate the inside surfaces with CLP 16 oil
Stock & outer bipod legs	N/A - Leave dry
Bipod inner legs	Lightly lubricate with CLP 16 oil
Bipod upper body	Lightly lubricate with a smear grease

6.3 Cleaning The Barrel & Chamber Before Firing

6.3.1



CAUTION

Before cleaning the rifle ensure that lenses of the telescopic sight are covered.

6.3.2 The use of a pull through is not recommended. The preferred option is to use a cleaning rod.

6.3.3 Care must still be exercised when using the cleaning rod to avoid causing damage to the bore and chamber.

6.3.4 The potential for chamber wear can be greatly reduced by using a rod guide to ensure that the cleaning rod is held in the in the centre of the bore

6.3.5 Lock the stock in the folded position, see section 5.2 “Unfolding & Folding The Stock”.

6.3.6 Securely hold the rifle on a level plane by a suitable means, ideally between the protected jaws of a bench vice, where available.

6.3.7 Depress the bolt release catch and remove the bolt, see section 5.6 “Fitting & Removal Of The Bolt”.

6.3.8



CAUTION

To avoid damaging the muzzle, the cleaning rod must always be inserted from the breech end.

6.3.9 Gently push the rod guide through the action and into chamber until a click is heard, signifying that the bolt catch has engaged.

6.3.10 Ensure the rod is clean before affixing a clean patch (10 cm x 5 cm) via a jag or the patch holder.

6.3.11



CAUTION

When cleaning the bore with patches, always work in one direction, breach to muzzle.

DO NOT pull used patches back through the bore.

6.3.12 Moisten a patch with Bore Solvent and push it once through the bore (via the rod guide) and of the muzzle to wet the bore.

6.3.13 Remove the soiled patch from the cleaning rod. **DO NOT** attempt to pull the patch back through the bore.

- 6.3.14 Remove the jag or the patch holder from the cleaning rod and refit with a correct sized phosphor bronze brush.
- 6.3.15 Whilst the bore is still wet, wet the brush with solvent and pass it completely through the bore in each direction several times.

Repeat with fresh solvent if necessary.

6.3.16



CAUTION

Always wet the bore with a patch before using a brush.

- 6.3.17 Refit the jag or patch holder to the cleaning rod and pass through a clean patch to dry the bore and chamber.

Remove the patch at the muzzle **DO NOT** pull it back through the bore.

Repeat this operation if necessary, until the patches come out clean (a light grey smudge is acceptable).

- 6.3.18 Where the rifle is to be stored for a lengthy period or when in a corrosion atmosphere a thin smear of oil should be left in the bore.
- 6.3.19 Moisten a patch with CLP 16 oil and pass it once through the bore.

6.4 Cleaning & Lubricating After Firing

- 6.4.1 It is recommended that the barrel be cleaned after each shooting.
- 6.4.2 The bore and chamber are easier to clean immediately after shooting, whilst the barrel is still warm.
- 6.4.3 Where this is not possible, the bore and chamber should be thoroughly oiled with CLP 16 oil or similar to assist later cleaning.

6.5 To Clean Heavy Copper Fouling

- 6.5.1 Heavy copper fouling may be seen from the muzzle as a copper coloured residue between the lands, although the heaviest fouling will occur towards the chamber.

Note: - This operation may not be required for every cleaning.

- 6.5.2 Clean the bore and chamber as above, see section 6.4 "Cleaning & Lubrication After Firing".
- 6.5.3 Remove the jag or the patch holder from the cleaning rod and refit with a correct sized phosphor bronze brush.
- 6.5.4 Allow the solvent to penetrate for approximately 5 minutes.
- 6.5.5 Refit the jag or patch holder to the cleaning rod and pass through a clean patch to dry the bore and chamber.

Remove the patch at the muzzle **DO NOT** pull it back through the bore.

Heavy fouling will show as blue on the patch. Repeat this operation as necessary until the patches come out clean.

6.5.6



CAUTION

Solvents must be used sparingly; any excess spillage outside of the barrel must be removed immediately.

7.0 Recommended Lubricates & Cleaning Solutions

Lubricant / Cleaner	Part Number	Typical Uses
CLP16 oil	AI15-0968	General cleaning and lubrication of action and rifle exterior.
Penetrating oil ZX-54	8030-99-923-1633	Lubrication of the trigger.
Grease XG 279	8030-99-220-2418	Parts inside the shroud. Scope mount.
Breakfree Bore Cleaner	BC4	Bore solvent

8.0 Operating Instructions – Telescope

8.1 General Description – Telescope

8.1.1 Accuracy International recommends the Schmidt und Bender 3-12x50 MKII 0.2 milli radian (MRAD) telescopic sight for use with the AW50.

8.1.2 The telescopic sight is composed of three drums, allowing adjustments for elevation, windage and parallax.

Full movement of the elevation and windage drums can be carried out in one complete turn. A click on either scale moves the sight reticule by 0.2 MRAD.

Stops are fitted at the beginning and at the end of the turn to aid the user to count of the elevation and windage clicks to when shooting at night.

The zoom can be adjusted in order to allow the sniper to magnify the target between three and twelve times

The eyepiece can be adjusted to accommodate dioptr deviation from +2 to -2 dioptr.

The design of the telescopic sight lenses allows more than 85 % light transmission. The telescopic sight is fitted with a laser protection filter.

All metal components have a hard anodised finish, which is easily cared for and offers a high resistance to scratches.

8.1.3 If ordered, the scope will be normally supplied fitted to the rifle having already been collimated (not zeroed).

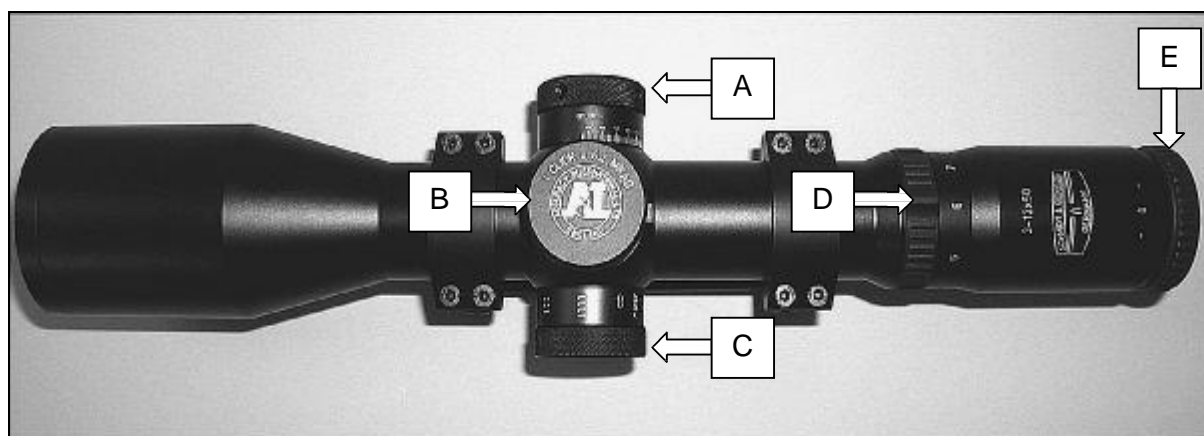

Fig. 18 Schmidt und Bender 3-12x50 MKII 0.2 MRAD Telescope

- | | | | |
|---|-----------------------------|---|------------------------|
| A | Windage Adjustment Turret | D | Magnification Ring |
| B | Elevation Adjustment Turret | E | Dioptr Adjustment Ring |
| C | Parallax Adjustment Turret | | |

8.2 AI Reticule

8.2.1 The reticule's lines, graduations and MIL dots are accurately positioned and dimensioned in order to serve as angular references.

The marks can be used as a guide to calculate distances, widths, heights and angles and they also can be used to aim off for wind velocity or moving targets.

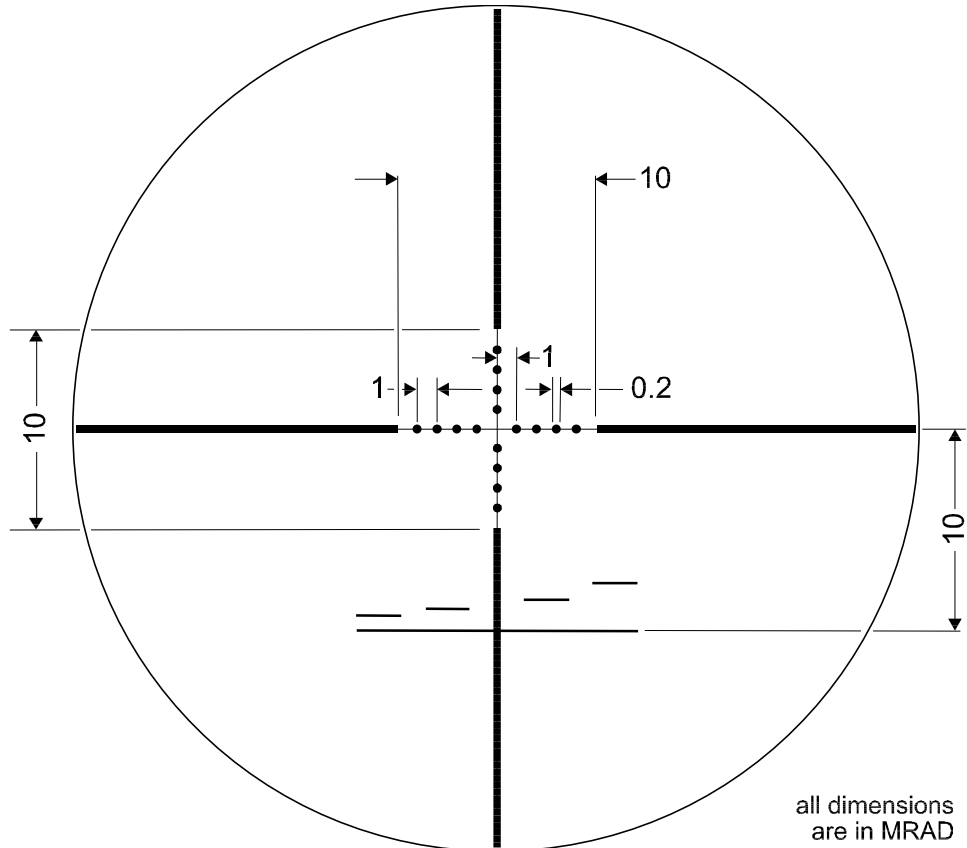

Fig. 19 AI Reticule

8.2.2 1 MRAD subtends 1 m at 1000 m. Therefore; the 0.2 MRAD dots on the reticule subtend 20 mm at 100 m.

The spacing between the dots is 1 MRAD or 100 mm at 100 m.

The thick bars are spaced 10 MRAD apart and are thick enough to enable sighting and "centring" of the target in bad light conditions.

8.2.3 To convert Mil-dot to minutes of angle, multiply the mils by 3.438

Example 5 mils x 3.438 = 17.19 MOA

- 8.2.4 10 MRAD below the horizontal line is a base line and 4 stadia for use as a dual-purpose range finder.
- 8.2.5 The stadia can be used to equate 1 m at distances of 400, 600, 800 and 1000 m respectively, which is approximately the distance between the top of a man's helmet and his belt (Fig. 20).

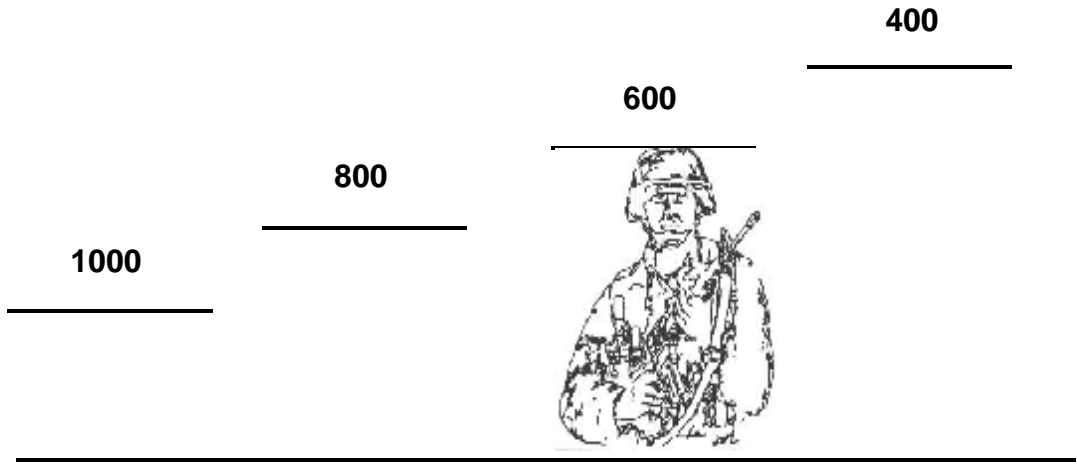

Fig. 20 Range Finding Stadia (400 – 1000 m)

- 8.2.6 The stadia can also be used equate 250 mm at distances of 100, 150, 200 and 250 m respectively, which is approximately the depth of a mans head (Fig0 21).

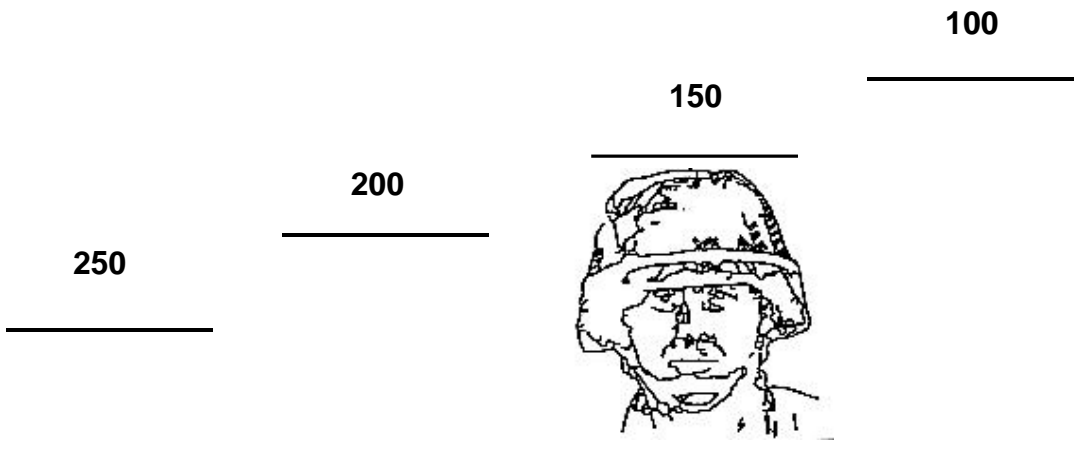

Fig. 21 Range Finding Stadia (100 – 250 m)

8.3 Eye Relief

8.3.1 The eye relief of the telescopic sight 3-12 x 50 MK II is set by the factory.

Since the bolt opening distance determines the head position on the cheekpiece, the eye relief remains constant.

8.4 Eye Relief Adjustment

8.4.1 To adjust the eye relief, adopt the prone firing position.

8.4.2 Adjust the bipod legs to suite the terrain.

8.4.3 With the cheek on the cheekpiece the distance between eye and eyepiece should be approximately 8 cm.

8.4.4 Where adjustment of the eye relief is required, loosen the three scope mount screws and move the sight / mount assembly forward or rearwards to the next position on the Picatinny rail.

8.4.5 Before re-tightening the mount securing screws ensure that the mount's recoil lugs are pushed forward against the back of the slot in the rail.

8.4.6



CAUTION

It is recommended that the scope is re-zeroed following any changes to its position.

Do not adjust the eye relief by unscrew the clamp-securing screws and slide the telescopic sight within its mount

8.4.7 When the distance between the eye and the eyepiece is too short, a shadow is produced at the extreme edges of the reticle and the field of view will be narrower (Fig. 22 (b)).

When the distance between the eye and the eyepiece is too long, the extreme edges of reticle are not visible and the field of view will be narrower (Fig. 22 (c)).

When the distance between the eye and the eyepiece is correct (approximately 7 cm), the whole of the reticle and the full field of view will be visible (Fig. 22 (a)).

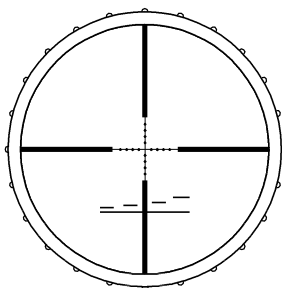

(a)

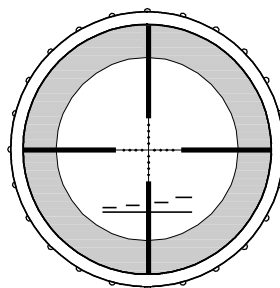

(b)

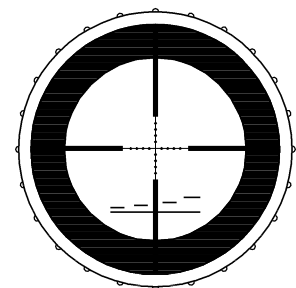

(c)

Fig. 22 Eye Relief

8.5 Eyepiece Dioptre Adjustment

- 8.5.1 A user with perfect sight will obtain a sharp image when the dot directly opposite the 0 position, however most users will need to adjust the dioptre to suit their eye
- 8.5.2 To adjust the dioptre, set the zoom to full power.
- 8.5.3 Whilst looking through the telescope, turn the eyepiece as far left as possible. Then turn it to the right until the reticule becomes both sharp and in focus.

8.6 Elevation Adjustment

- 8.6.1 The Elevation drum is the turret located on the top of the telescope.
- 8.6.2 It is used to apply aiming corrections in relation of the target range.
- 8.6.3 It has two scales: -
 - Lower scale is graduated from 0 to 22 MRAD.
 - Upper scale is graduated from 1 to 15 (corresponding respectively to 100 m and 1500 m).
- 8.6.4 The upper scale provides an indication that the range has been correctly applied.

8.7 Windage Adjustment

- 8.7.1 The Windage drum is the turret located on the right hand side of the telescope.
- 8.7.2 It is used to apply aiming corrections in relation to the wind velocity.
- 8.7.3 It has one scale graduated from 0 to 6 MRAD to the left and from 0 to 6 MRAD to the right.

8.8 Parallax Adjustment

- 8.8.1 The Parallax drum is the third turret on the left hand side of the telescope. This feature allows the user to adjust the telescopic sight's parallax without having to take his eye of the target.
- 8.8.2 The range of adjustment is between 50 and 1000 m with an infinity marking.
- 8.8.3 If the distance is known, turn the drum so that the desired distance aligns with the index point on the turret.
- 8.8.4 If the distance is unknown, set the zoom to full power.
- 8.8.5 Whilst looking through the telescope, move the parallax drum in the direction of the roughly estimated distance until the image is at its as sharpest.
- 8.8.6 Now purposely move your eye up and down in the area of the exit pupil whilst simultaneously correcting the parallax compensation drum until no movement is visible between the reticule's centre and the target.

Note: - This may also be used for basic range finding.

9.0 User Maintenance – Telescope

9.1 General

9.1.1 The telescope is non-user maintainable. Under no circumstances should the user conduct any more maintenance other than routine cleaning of its external surfaces, the object glass and eye lens.

9.1.2 A qualified armourer should carry out all further maintenance. If doubt users should seek the armourer's advice.

9.2 Cleaning The Telescope

9.2.1 It is not necessary to remove the telescope from the rifle to clean it.

9.2.3 The lenses are the most important and most easily damaged part of the sight.

9.2.4



CAUTION

The protective caps should always be fitted when the sight is not in use.

Lens should not be touched with anything except the recommended cleaning materials.

When cleaning the lenses, always use a gentle circular motion, working from the centre outwards.

9.2.5 To clean the lenses, remove the caps and sunshade (where fitted).

9.2.6 Large pieces of debris can be removed using a soft lens brush.

9.2.7 Where the brush fails to remove debris adhered to the lens' surface, it should be washed in soapy water to gently loosen and wash away the deposits.

9.2.8 The lens should then be wiped dry with a clean lens cloth.

9.2.9 Spots and stains can be removed by wiping the affected area with clean lens cloth or disposal lens tissues wetted with a drop of methylated sprits.

9.2.10 Dust and smears are removed by breathing gently on the lens before carefully polishing with a clean lens cloth or disposal lens tissues.

9.2.11 Following cleaning, replace the caps and sunshade (where fitted).

9.2.12 The scope's body should be cleaned by a wipe over with a clean cloth.

9.2.13 When it is necessary to remove the sight from the rifle, the opportunity should be taken to lightly oil the sight retaining screws and the mounting bracket after it has been cleaned.

9.2.14

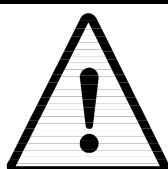

CAUTION

Ensure no oil comes into contact with the surface of the lenses.

10.0 Accuracy & Ammunition

10.1.1 All of Accuracy International's sniper rifles are capable of very fine accuracy and consistent first shot capability.

However, this performance is reliant on the quality and capability of the ammunition used.

No matter how good the rifle is it will only shoot to the capability of the ammunition.

For optimum results Match grade ammunition with specified accuracy capability should be used.

11.0 User Tips

- Obtain a shooting position where the bolt can be manipulated without head movement and which minimises rifle movement.
- Practice movements that are slow and smooth when using the rifle as a hide may be compromised by rapid, jerky movements.
- Ensure that all the rifle's support points (bipod and third leg) are in contact with the ground to minimise pulse beat.
- When using the bipod, always push into the bipod so that on firing the rifle recoils naturally (without resistance) about the ball joint.
- Pulling back on the bipod can give serious elevation at the target, especially on soft ground.
- When holding the breath during firing it is better to exhale rather than inhale. This reduces ground pressure on the abdomen and reduces pulse.
- Press the thumb of the right hand on top of the action to aid leverage when opening the bolt to assist the removal of tight extractions.
- ALWAYS** ensure that the bolt is fully closed before reopening so that any live round that is already in the chamber, will be gripped by the extractor and ejected.
- When cycling the bolt for repeat shots, **ALWAYS** ensure that bolt is retracted fully rearwards i.e. to touch the bolt stop, to minimise the chance of a misfeed.
- Watch for the fall of the shot in case a quick follow up shot is necessary.

12.0 Customer Communications

12.1.1 Accuracy International welcomes your feedback on our products and service, both negative and positive.

We are able to offer Service/ Repair and Spares packages.

Our Sales team are available to discuss how we may be of assistance to you now and in the future

UK & Rest Of World (Excluding USA)

Accuracy International Ltd.
P.O. Box 81
Portsmouth
Hampshire
PO3 5SJ
United Kingdom

Tel: +44 (0)23 9267 1225

Fax: +44 (0)23 9269 1852

Email: precision@accint.org

USA Only

Accuracy International North America
P.O. Box 5267
Oak Ridge
TN 37831
USA

Tel: (865) 482-0330

Fax: (865) 482-0336

Email: AINA@accuracyinternational.org

